

**CENTAUR EXERCISERS  
DO NOT OPERATE  
ON A SOLAR SYSTEM**

# **CENTAUR**



## **PROGRAMMABLE FREE FLOW EQUINECISER**

**CONCRETE & ELECTRICAL  
INSTALLATION DIAGRAMS**

**5761 RIDGEVIEW AVENUE  
MIRA LOMA, CALIFORNIA 91752  
(951) 685-7337 FAX (951) 685-0341  
1-800-962-8050  
www.hotwalkers.com  
www.equinecisers.com  
E-Mail: centaur@hotwalkers.com**

**SERVICE/FIELD TECH  
STEVE ANTHONY  
951-537-4539(MOBILE)  
EM 1984ANTHONYS@GMAIL.COM**

Revised 4/2018

## Grading Diagram

# **CENTAUR EXERCISERS DO NOT OPERATE ON A SOLAR SYSTEM**

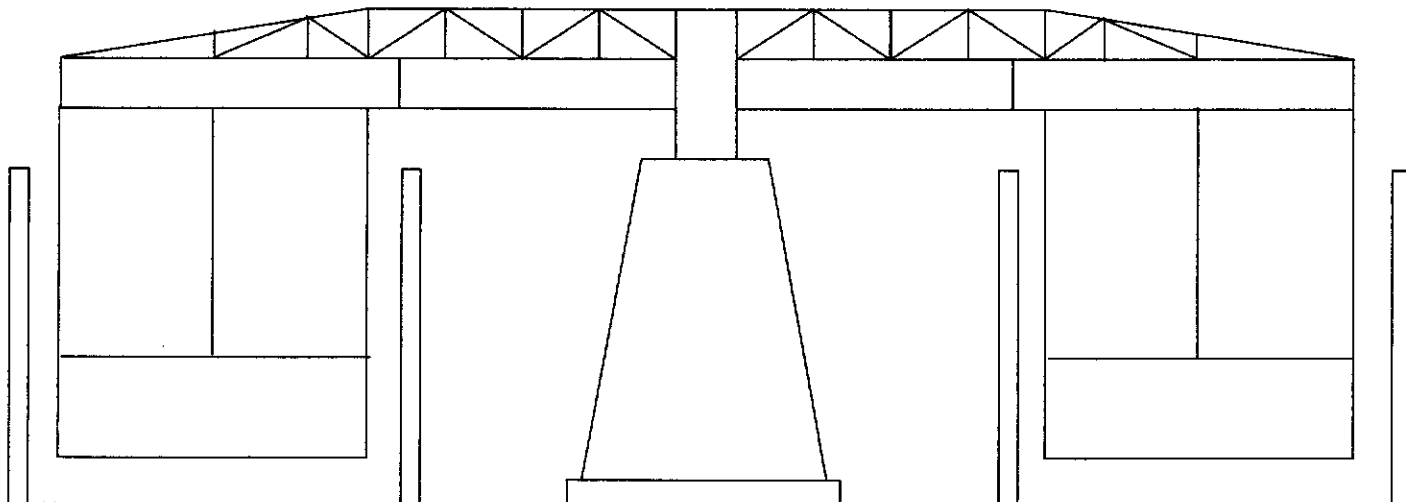

Entire Pad MUST be flat, NO Grade Deviation or Fall (NO 1% GRADE FOR DRAINAGE)

Pad will be 4 ft. larger than the diameter of the Equineciser Model.

TOP OF THE SLAB MUST BE 6" ABOVE FINISHED EXERCISING SURFACE  
(THE ACTUAL FOOTING/SURFACE HORSES WILL BE EXERCISING ON).

Apply FINAL exercising surface, AFTER fencing has been INSTALLED.

Please Note: When most Graders and Grading Contractors hear 0% grade, they will grade at 1% to allow for proper drainage. While this is suitable for most buildings, it is NOT suitable for the Centaur Equinecisers. To install the fencing, and the screens properly there must be a true 0% grade. From 4 feet, outside of the diameter desired, and the diameter desired, the ground must be completely FLAT.

Due to numerous installations where the grading and/or the electrical was not done correctly, our Project Coordinator, has had to layover, and incurred more costs than necessary. Now we charge an additional \$1,000.00 to our clients, should our Project Coordinator arrive at the jobsite, and find the pad and/or electrical incorrect. This price is for food, lodging, truck & tool rentals for 2 additional days ONLY, thereafter it is, \$500.00 per day.

The above prices are all based on geographical location of jobsite, the prices could vary upwards. Should you choose one of the optional installation packages offered by Centaur, the above mentioned charges are NOT included in the prices, and will be added to the installation prices if necessary.

# ATTENTION:

When most Graders and Grading Contractors hear 0% grade, they will grade at 1% to allow for proper drainage. While this is suitable for most buildings, it is **NOT** suitable for the Centaur Equinecisers. To install the fencing, and the screens properly there must be a **true 0% grade**. From 4 feet, outside of the diameter desired, and the diameter desired, the ground must be completely **FLAT**.

# CONCRETE DIAGRAM 1

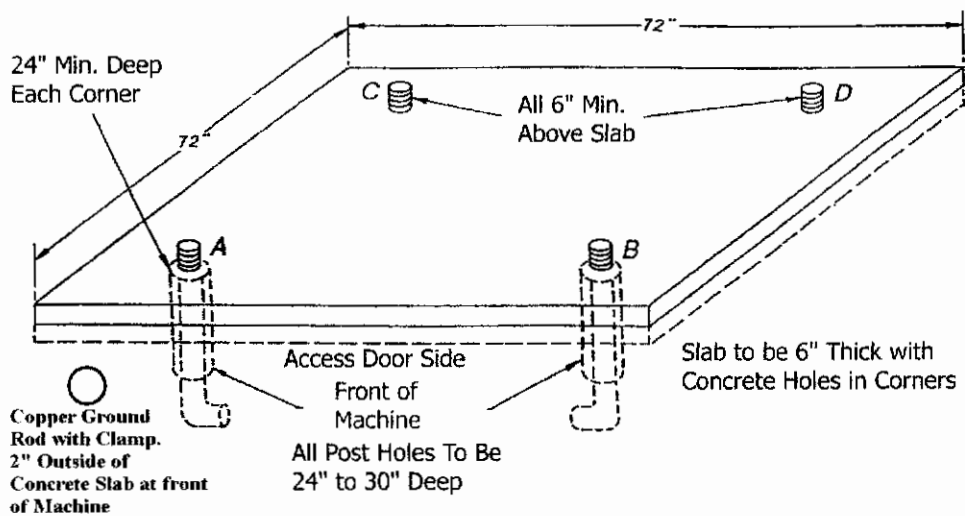

Angular Projection is a visual aid ONLY and is NOT to be scaled.

**Electrical Conduits MUST be installed Prior to concrete pour, see Electrical Diagrams for details.**

**Center Point for Concrete Anchors:**

- A to B = 46 1/2"
- C to D = 46 1/2"
- A to C = 57 1/2"
- B to D = 57 1/2"

**Diagonals:**

- A to D = 74 1/2"
- B to C = 74 1/2"

Anchor Bolts are 3/4" in diameter, and can either be 18" or 24" in length.

**NOTE: All Dimensions are from the Bolts NOT the Slab.**

Pad should be 72" X 72" (6 ft. X 6 ft.) Square.

## CONCRETE DIAGRAM 2

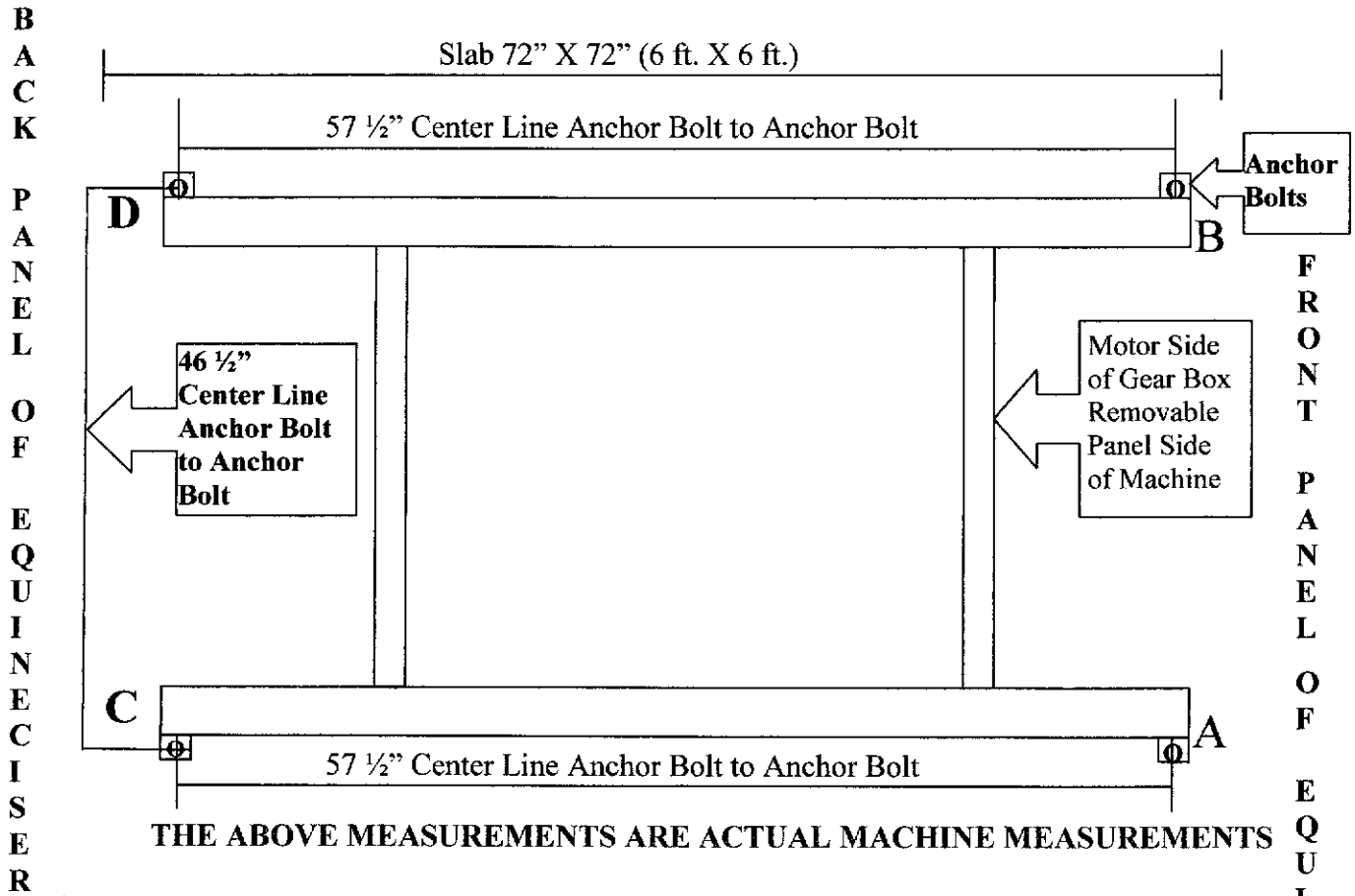

### Center Point for Concrete Anchors:

- A to B = 46 1/2"
- C to D = 46 1/2"
- A to C = 57 1/2"
- B to D = 57 1/2"

### Diagonals:

- A to D = 74 1/2"
- B to C = 74 1/2"

Anchor Bolts are 3/4" in diameter, and can either be 18" or 24" in length.

**NOTE: All Dimensions are from the Bolts NOT the Slab.**

Pad should be 72" X 72" (6 ft. X 6 ft.) Square.

Machine **MUST** be 6" above final grade finish grade of horse walking surface Area.

# CENTAUR EXERCISERS DO NOT OPERATE ON A SOLAR SYSTEM

General Electrical Hookup  
Overview for Centaur  
Free Flow Equinecisers

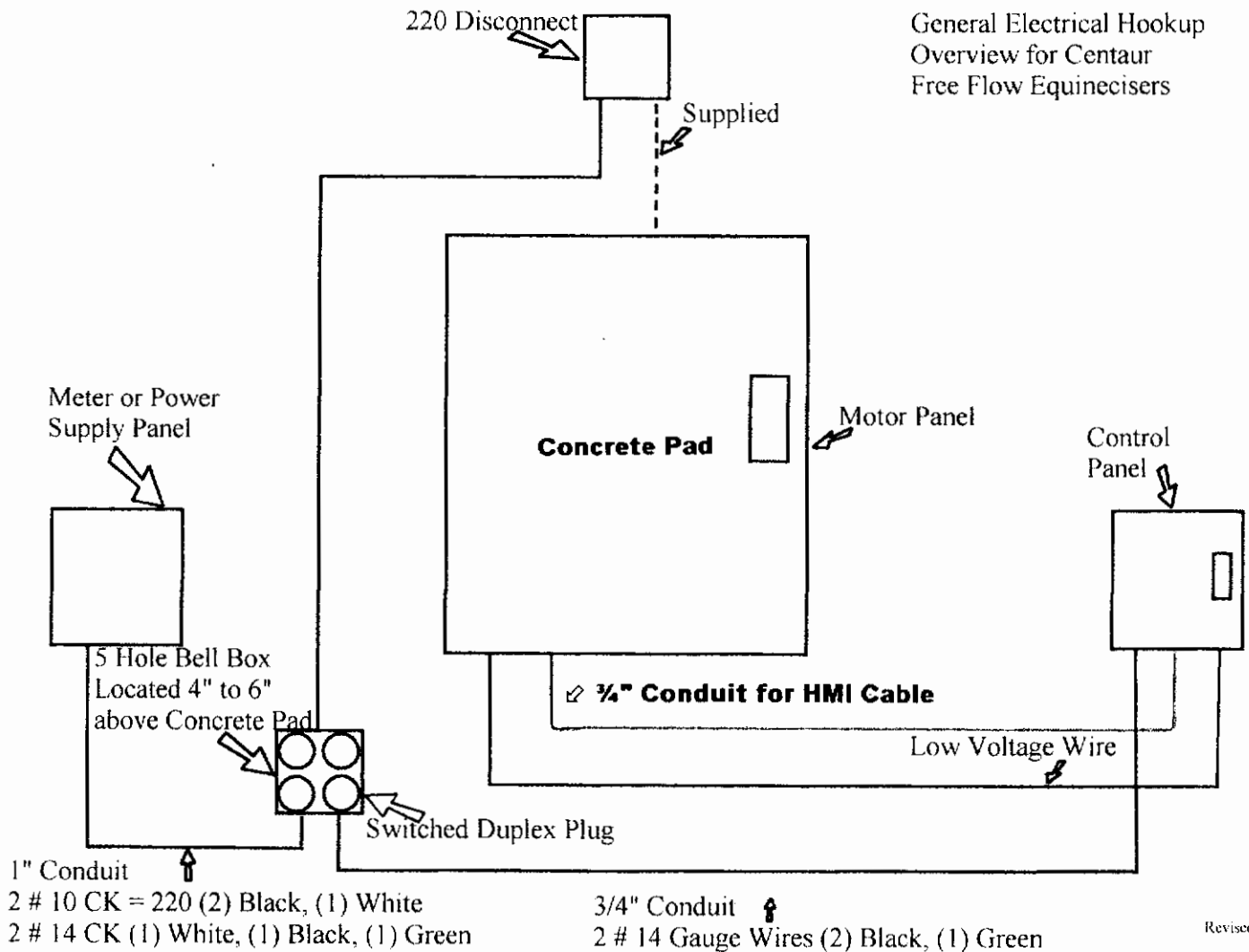

Revised 4/02

Center Ground Rod (2" Outside of concrete slab at front of machine.)

**REQUIRED  
GROUND ROD  
8-10 FOOT COPPER ONLY  
GROUND TO HOT WALKER  
STEEL BASE/ GROUND CONTROL**

# ELECTRICAL DIAGRAM 1

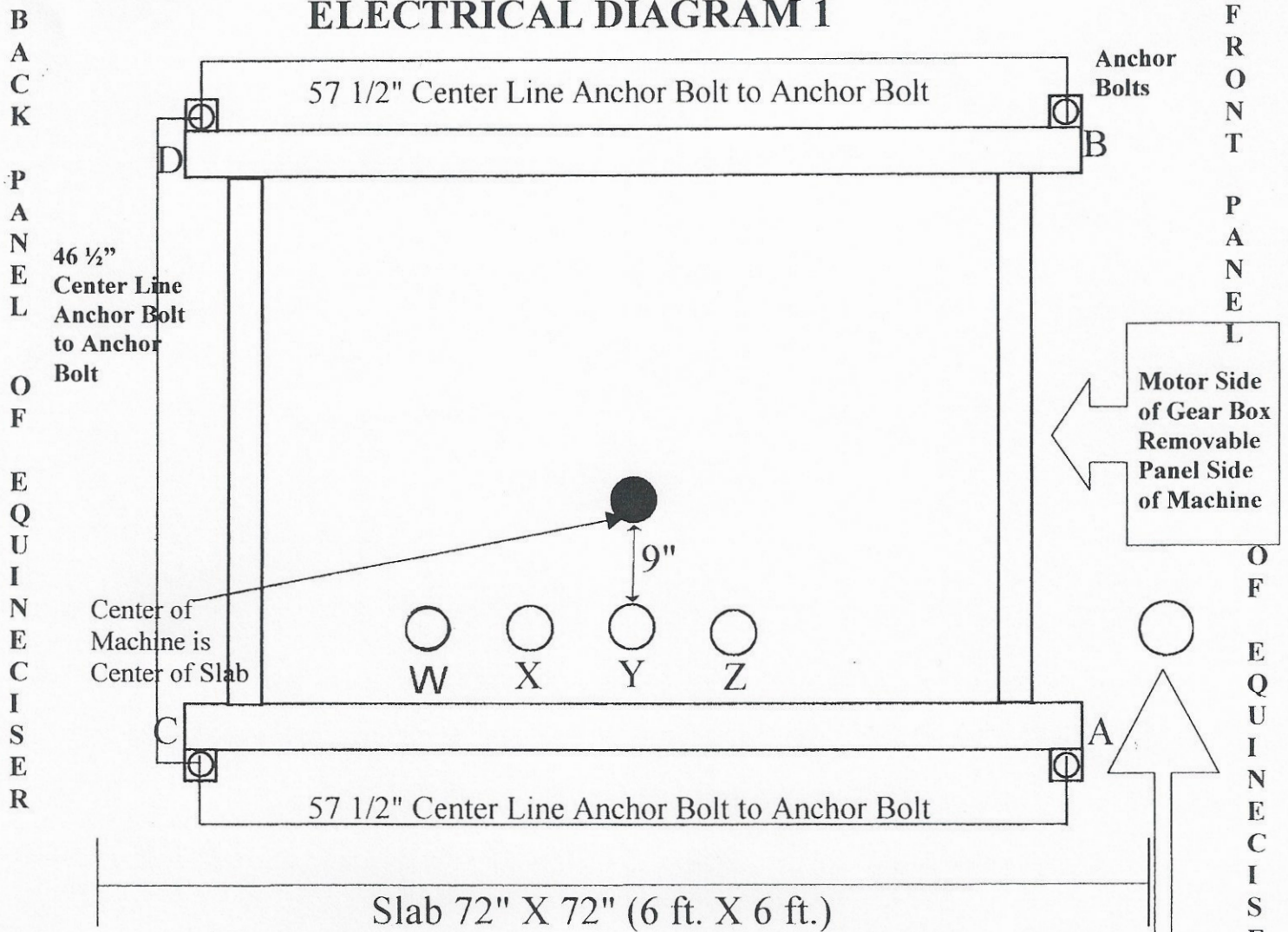

THE ABOVE MEASUREMENTS ARE ACTUAL MACHINE MEASUREMENTS

**W = 3/4" Conduit for HMI Cable**

**X = Conduit to Power Supply**  
20 AMP 220 Volt Circuit and  
1 - 15 AMP 110 Volt Circuit,  
in ONE Conduit. Both Circuits are to

**Y = Conduit to Control Panel**

3/4" Conduit with TWO Black wires  
and ONE Green wire.

**Z = Conduit to Control Panel**

3/4" Conduit for wire loom.  
(Wire loom supplied by Centaur)

**IF RUN IS LONGER THAN 50 FT. CONTACT CENTAUR CORP.**

**USE #10 WIRE IF RUN IS UNDER 100 FT. For 220 Volt Power to Equineciser.**

**Use #12 Wire 110 Volt to Shocker.**

**IF RUN IS LONGER THAN 100 FT. CONTACT CENTAUR CORP.**

**X & Y To be connected into a 2  
gang weather proof box**

**CENTAUR EXERCISERS  
DO NOT OPERATE  
ON A SOLAR SYSTEM**

**Copper Ground  
Rod with Clamp  
MUST BE  
INSTALLED.  
(2" Outside of  
concrete slab at  
front of machine.)**

# Centaur Free Flow Equineciser Electrical Diagram 2

**REQUIRED  
GROUND ROD  
8-10 FOOT COPPER ONLY  
GROUND TO HOT WALKER  
STEEL BASE/ GROUND CONTROL**

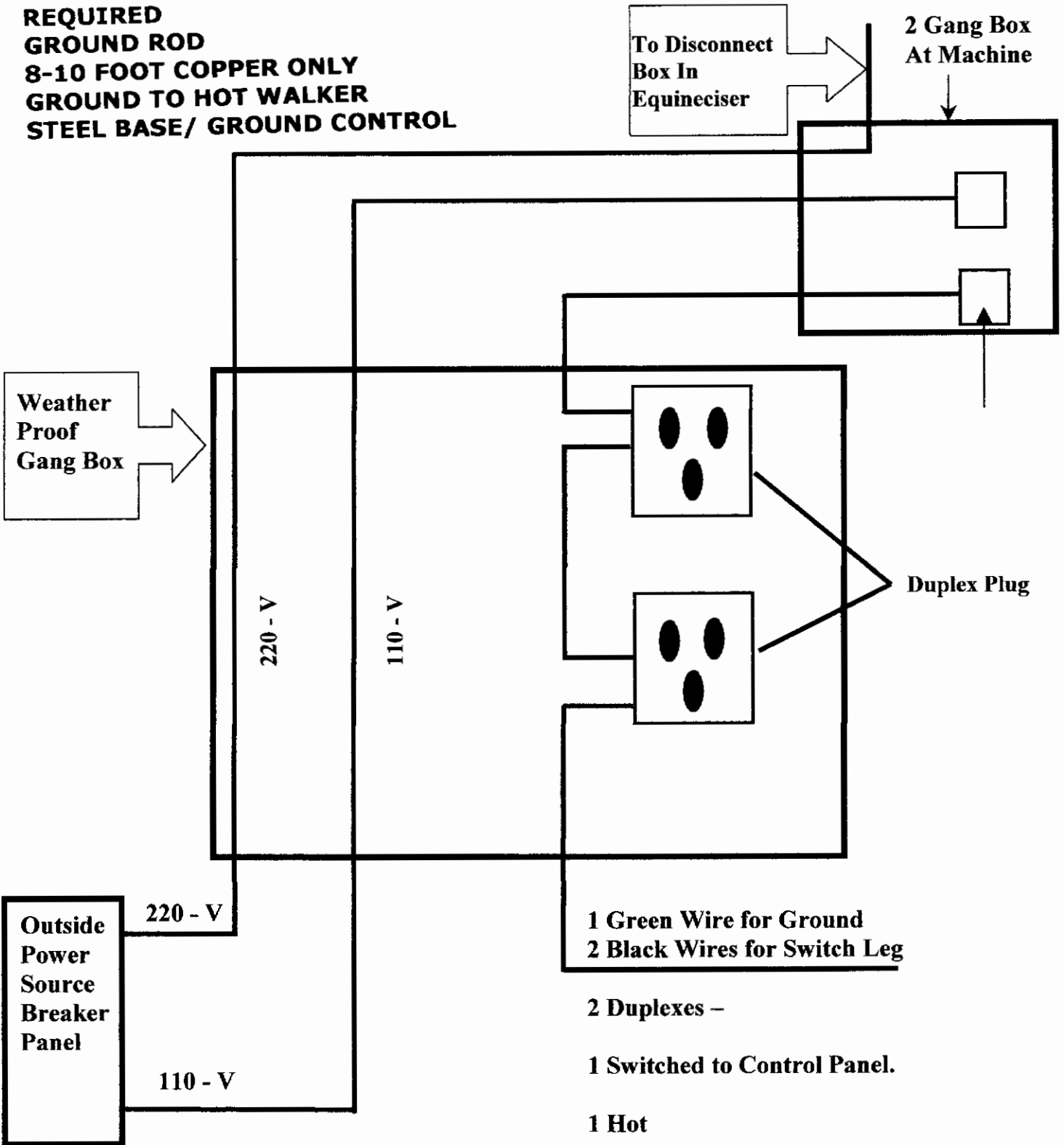

**Call our office 1-800-962-8050 with any questions you might have!**



# Centaur Free Flow Equineciser Electrical Diagram 3

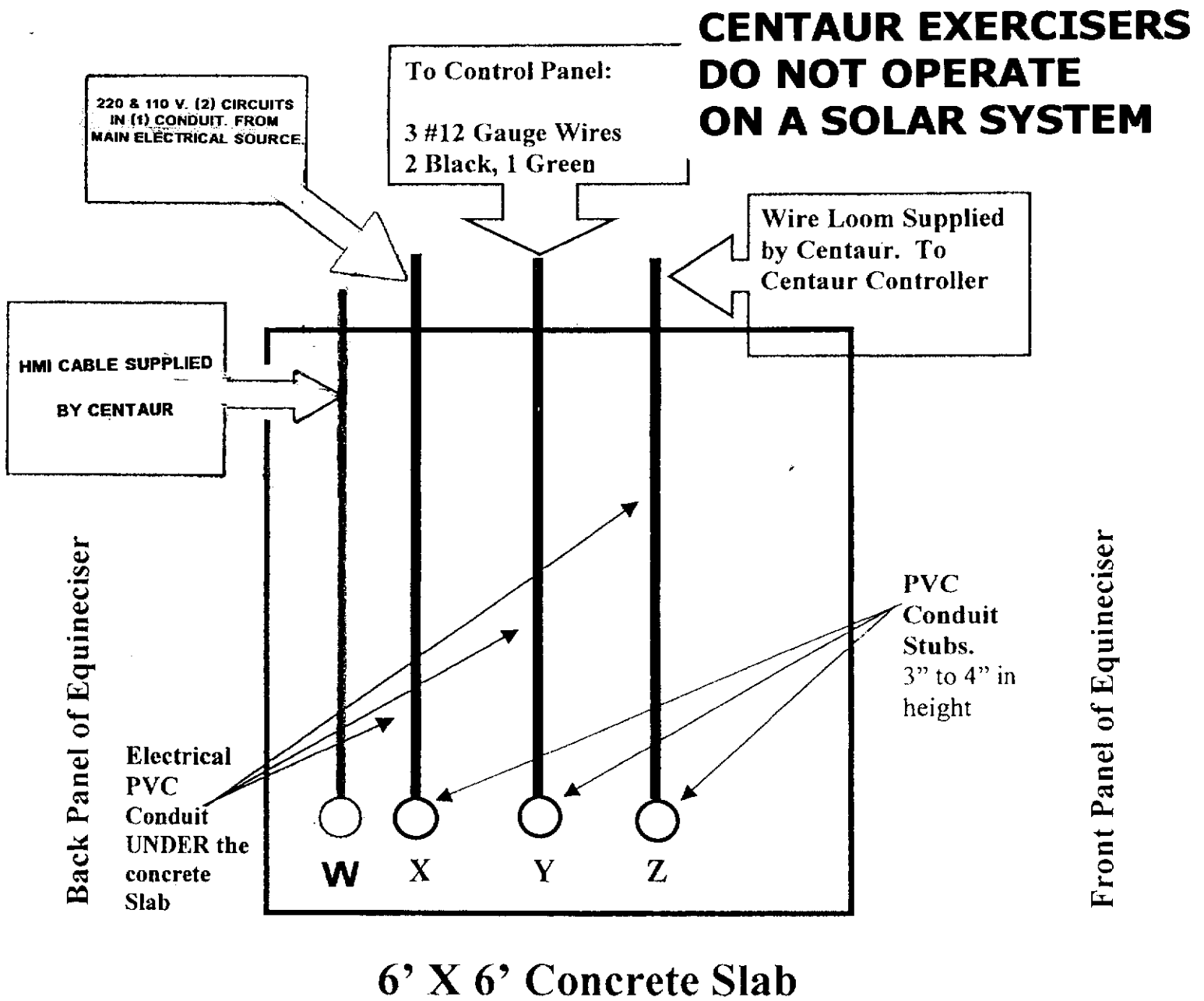

Call our office 1-800-962-8050 with any questions you might have!

X & Y To be connected into a 2 gang weather proof box

Copper Ground Rod with Clamp **MUST BE INSTALLED.**  
(2" Outside of concrete slab at front of machine.)

Control

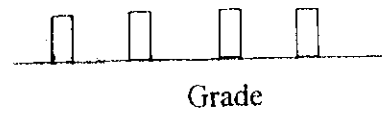
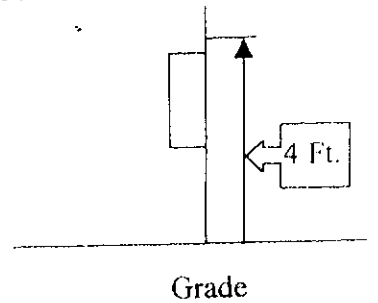

Electrical Stubs to Be **NO** more than 4 inches above slab.

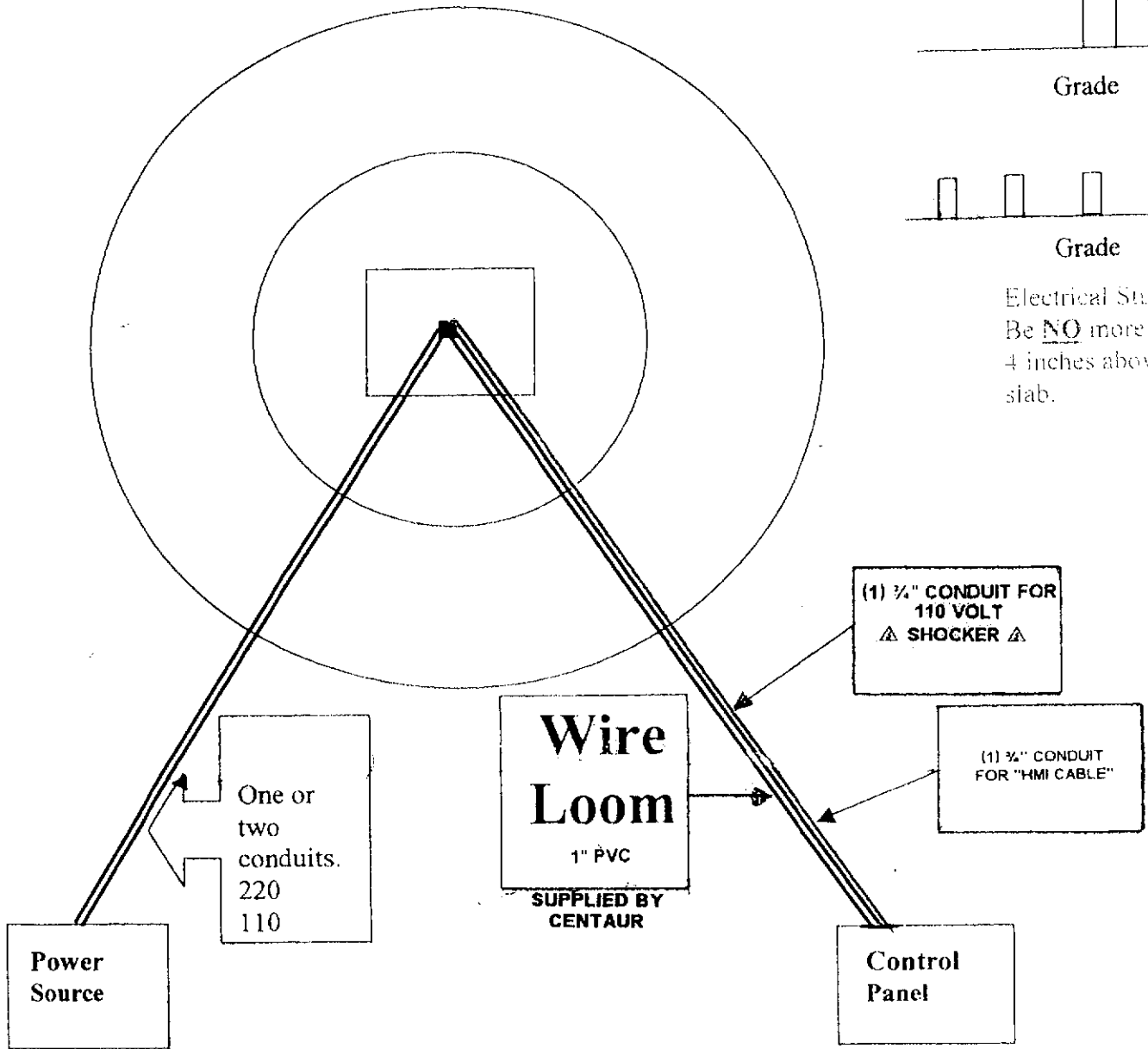

**NEED**

110 Circuit to Duplex plug at Equineciser, Switched to Control Panel.

220 to Disconnect at Equineciser.

**REQUIRED**

**GROUND ROD**

**8-10 FOOT COPPER ONLY**

**GROUND TO HOT WALKER**

**STEEL BASE/ GROUND CONTROL**

# Centaur Equinecisers POWERFLEX Control Unit with Timer Wiring Diagram On Backside of Centaur Control Box

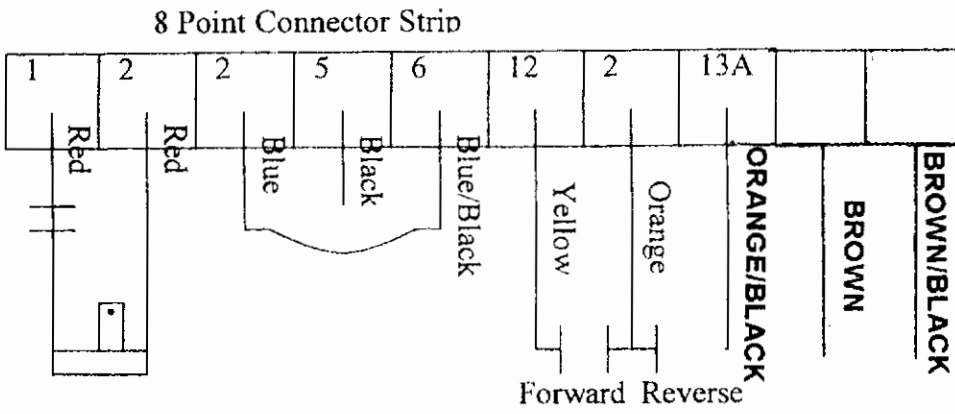

## Backside of Centaur Control Box

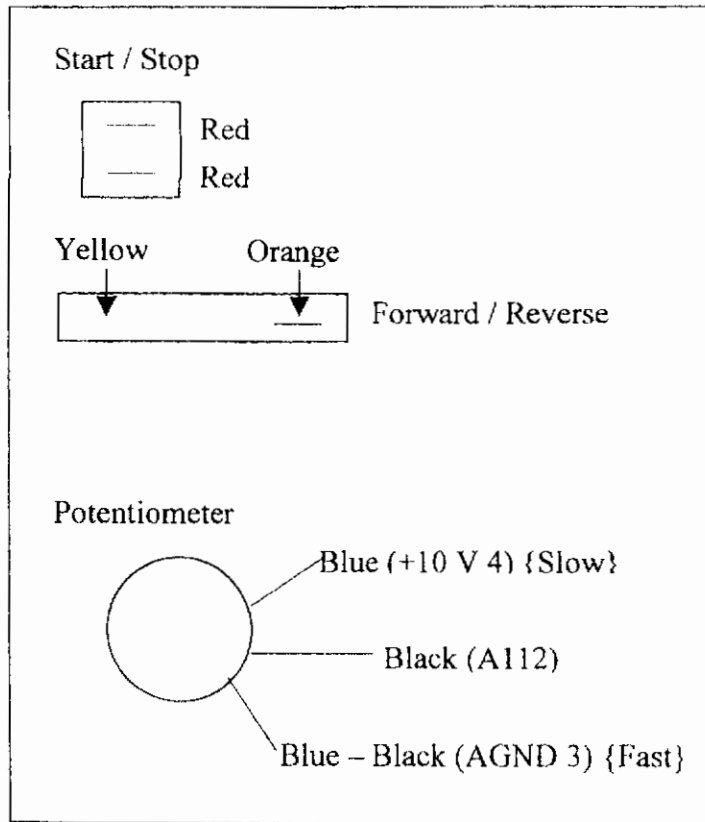

# Centaur Equinecisers Control without Timer

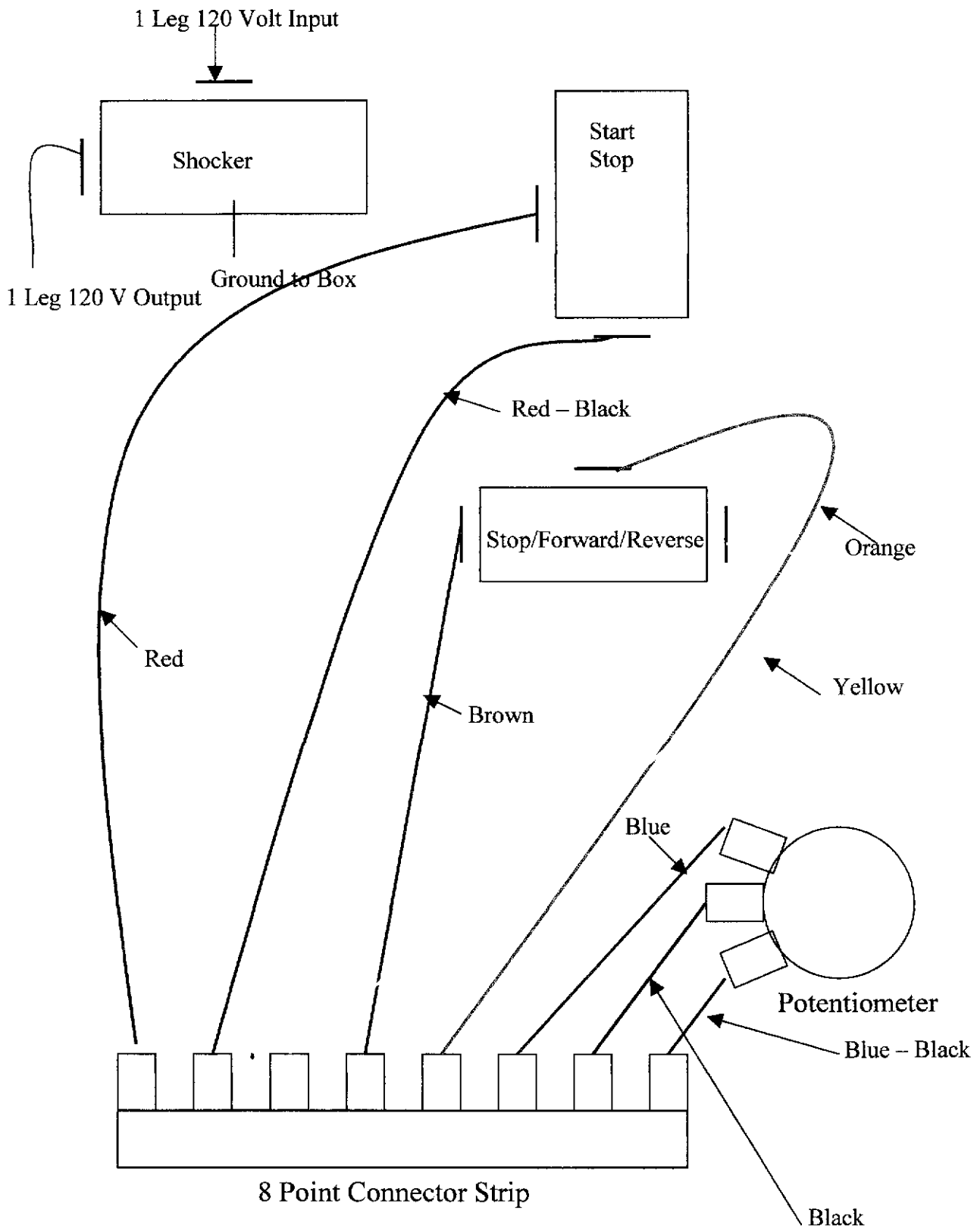

## Centaur Equinecisers POWERFLEX Controller with Timer

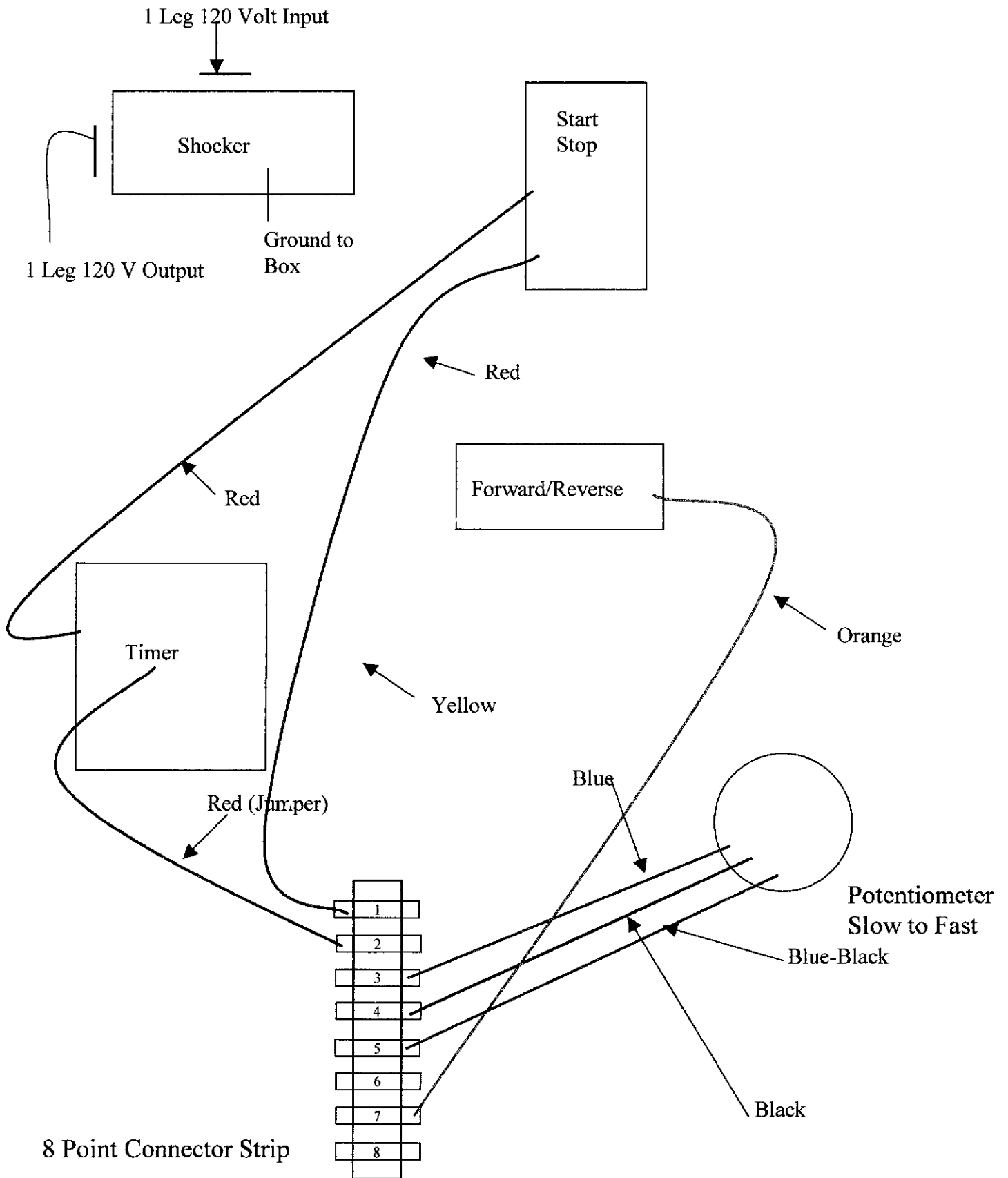

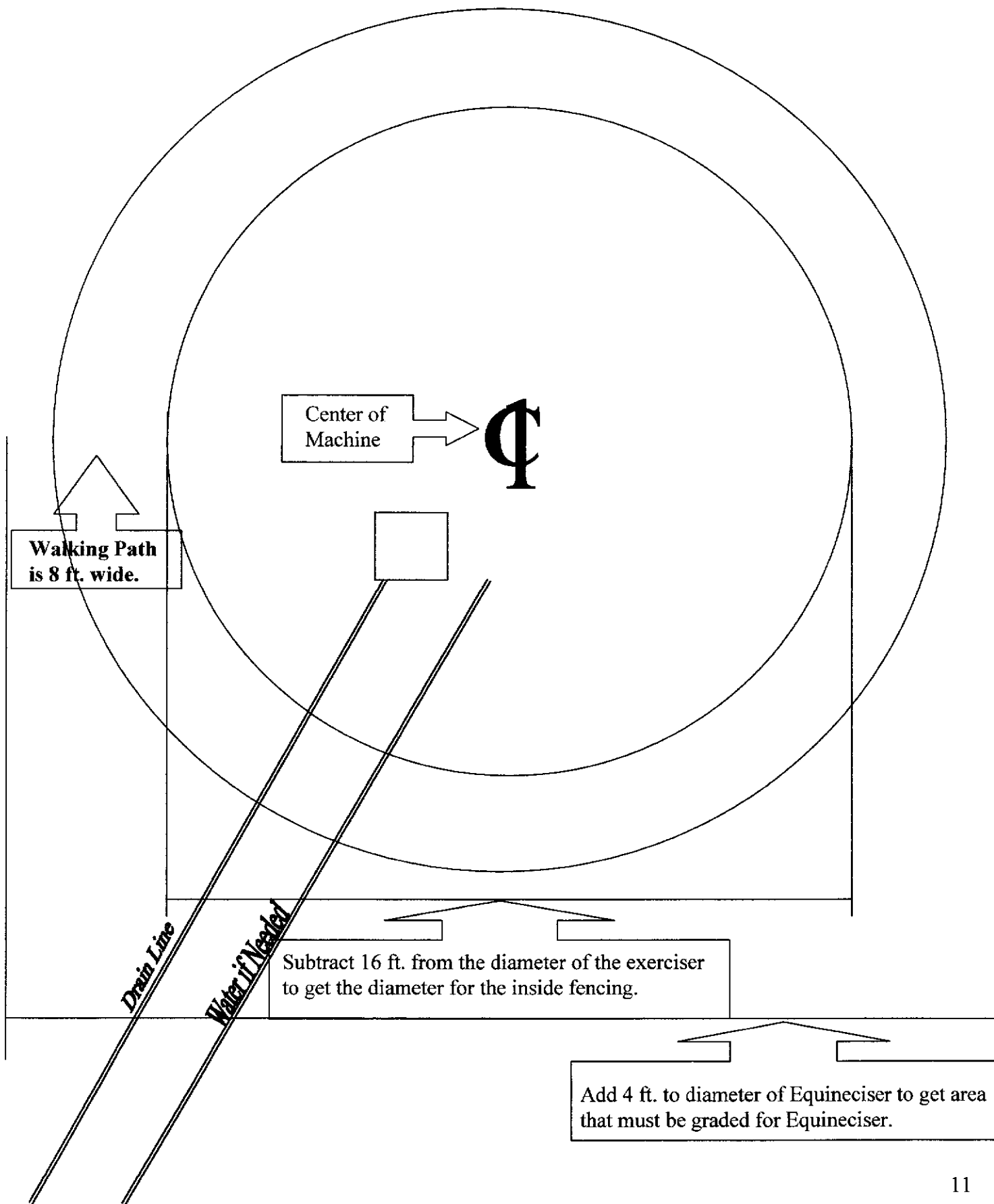

# Optional Sprinkler System for Exerciser's Path, for Centaur Free Flow Equineciser

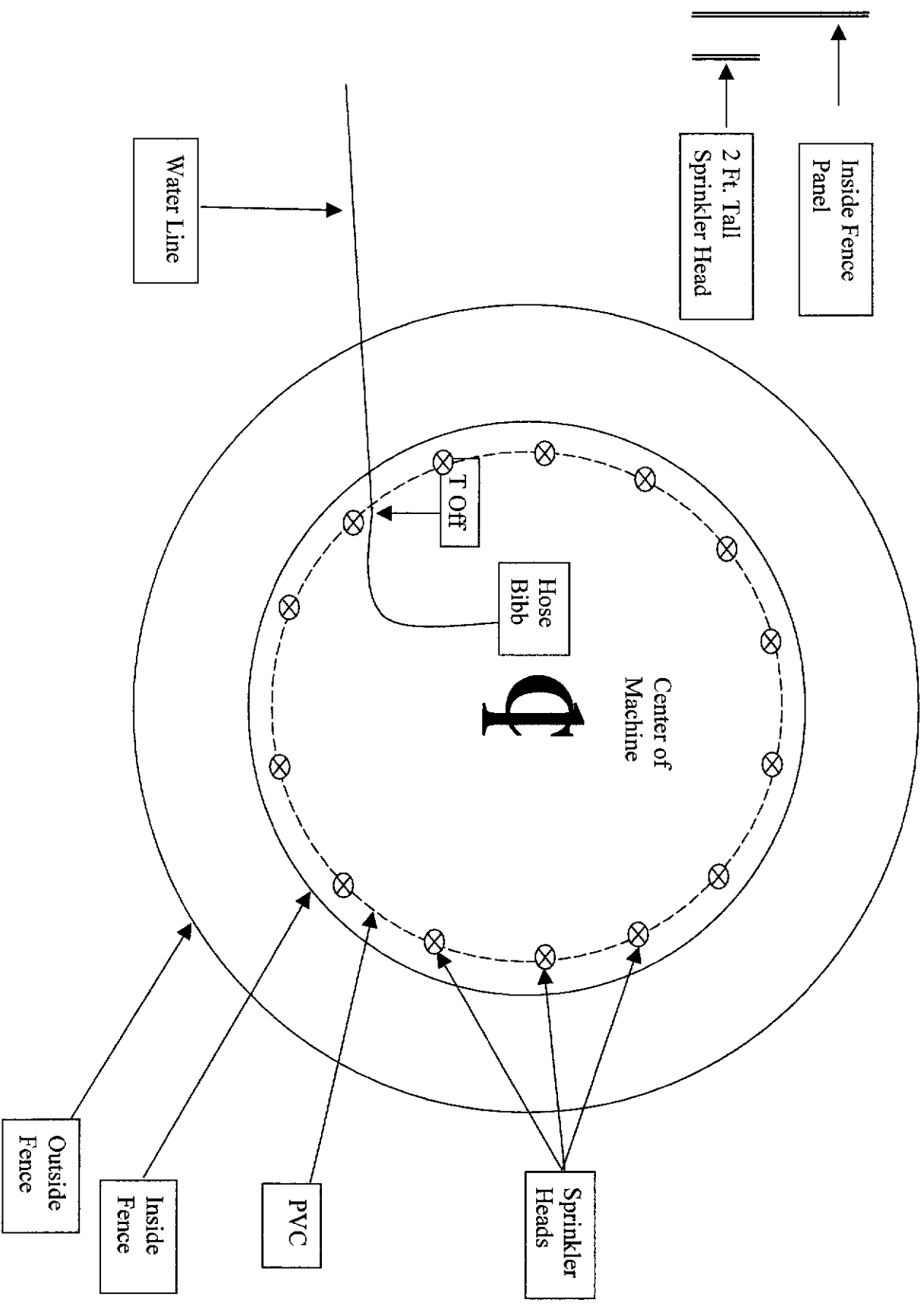

# Optional Drain Line for Centaur Free Flow Equineciser

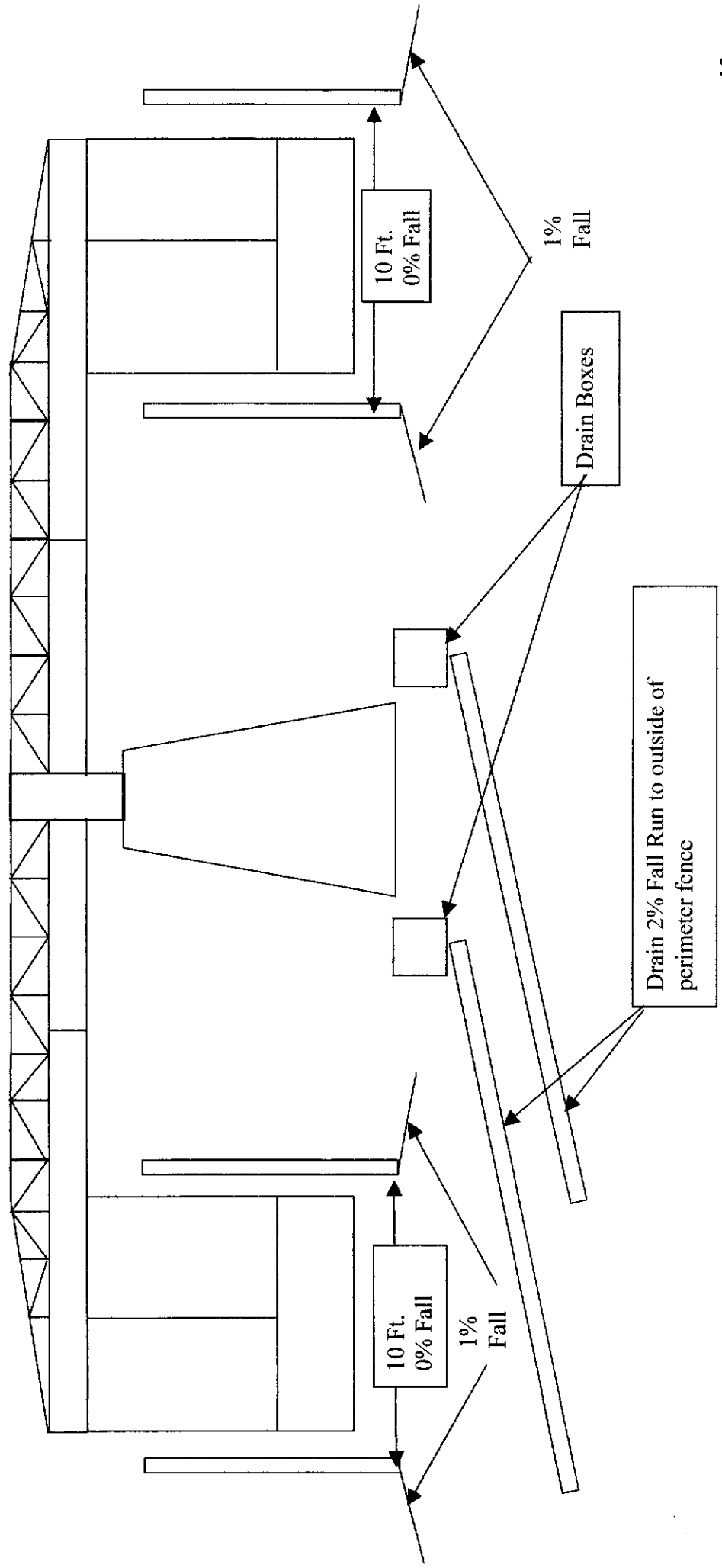



## **Installation Instructions for Screen Chargers on all Models of Centaur Free Flow Equinecisers**

To install the electrical charger system you will find a strand of black wire taped to the vertical shaft inside the Equineciser itself.

There is a large keyway (slot) below the top pillow block bearing, on the vertical steel shaft.

Take the black wire & uncoil it & feed it through the shaft's keyway (slot) so the wire comes out above the pillow block bearing & under the large flat steel pan.

You will find a hole  $\frac{1}{4}$  in. diameter in the steel pan. Insert the black wire through the hole (from the bottom of the pan) and pull all of the wire through it. So it is under the arm inserts on the round metal shaft, and is resting on the flat steel pan.

At the far end of each small arm by the screen end you will find a hole in the  $2\frac{1}{2}$ " X  $2\frac{1}{2}$ " steel arm, using an electrician's snake, slide it through the hole all the way back through the 3" X 3" main support arm.

You will find a hole also in the 3" X 3" using a wire hook grab the electrical snake & pull it through the hole in the 3" X 3" arm.

There were individual black wires sent to you, 1 for each arm.

Attach the 1 piece of black wire to the snake & pull it through the arm. Pull slowly so not to rip insulation from special wire.

Leave about 3 ft. + by head assembly & allow the rest of the wire to pass out of the  $2\frac{1}{2}$ " X  $2\frac{1}{2}$ " arm hole. The arm hole will be on the bottom of the arm

There were also some pieces of clear plastic tubing 1' each sent to you, (it takes 2 – 1 ft. pieces of clear plastic tubing for each arm, one for the 3" X 3" hole & one for the  $2\frac{1}{2}$ " X  $2\frac{1}{2}$ " hole.

Take each of the 1 ft. clear plastic tubes & slide it over the black wire where it enters the 3" X 3" &  $2\frac{1}{2}$ " X  $2\frac{1}{2}$ " arms. The plastic keeps the black wire from rubbing against the steel arm and shorting out.

On top of each screen frame that hangs from the arm with chain, place 1 – lug receiver 6" in from inside of frame – Use a self-drilling tek screw to anchor the lug.

Strip back the black wire & prior to attachment wrap the black wire around a large screwdriver shaft, to make a tight coil – similar to your phone cord. This will allow you to raise or lower the screen chains without tearing the wire loose from the lug connections.

Now go back & take each of the arm wires by the tower head assembly & tie them all together with the one wire that came up through the key slot on the vertical shaft.

Use 1 large wire nut to tie them all together then wrap with electrician's splicing tape tightly. Then wrap again with regular electrical tape the wires simply lay on top of the large round steel pan near the central vertical shaft.

See other drawings on how to connect shocker wires from controller to the charge box, (the charge box is mounted on inside wall of the Equineciser). Also refer to the standard concrete & electrical installation information that was also sent to you.

To test if screens are charged: Take a piece of wire and wrap around the ground wire and with the other end of the wire stripped back, touch the screen frame or welded wire on screen you should see a pulsating spark or snap if all connections are grounded & connected properly.

**NOTE:** Moving Screen **CANNOT** touch the Centaur Standard Steel Fence Panels when in place or moving.

If the screens rub or touch they will short out the charger box.